



GM12-200

12V 200AH AGM Battery

Characteristics

Nominal Voltage		12V
Nominal Capacity (10 hour rate)		200Ah
Capacity 25°C (77°F)	10 hour rate (20A)	200Ah
	3 hour rate (50A)	150Ah
	1 hour rate (110A)	110Ah
Internal Resistance	Full Charged Battery 25°C (77°F)	≤5mΩ
Cyclic Life	50%(C ₁₀) Depth of discharge	1000Times
	30%(C ₁₀) Depth of discharge	1200Times
	20%(C ₁₀) Depth of discharge	1500Times
Float Life	25°C (77°F) Float charge at 13.8V	About 10-12 Years
Capacity affected by Temperature (10 hour)	40°C (104°F)	102%
	25°C (77°F)	100%
	0°C (32°F)	85%
	-15°C (5°F)	65%
Self-Discharge 25°C (77°F)	Capacity after 3 month storage	90%
	Capacity after 6 month storage	80%
	Capacity after 12 month storage	62%
Charge (Constant Voltage)	Cycle	Initial Charging Current Less than 60A Voltage 14.6-15.0V
	Float	Voltage 13.5-13.8V
Operating Temperature Range during Charging/ Discharging		-15°C to 45°C

Product Image



Packing

Battery (LxWxH)	mm±1	522×240×244
	inch	20.6×9.45×9.53
Box (LxWxH)	mm±2	546×264×290
	inch	21.5×10.4×11.5
Quantity Per Box		1 PCS
Net weight Per Cell		56.5KG±200G
Net weight Per Box		56.5KG
Gross Weight		57KG

Discharge Curve

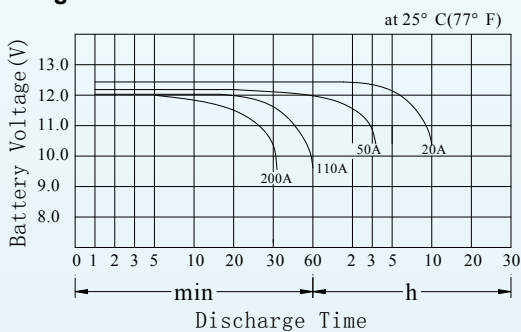

Product Dimensions

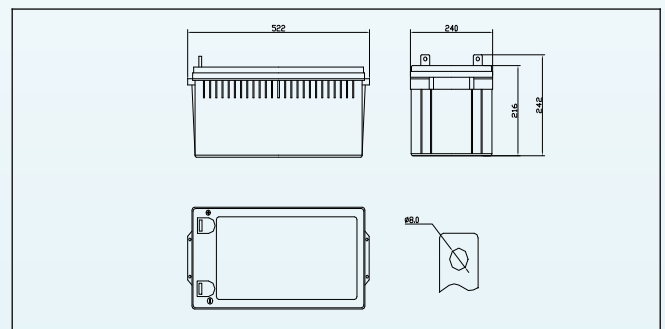

Battery Construction

Component	Positive plate	Negative plate	Container	Safety valve	Terminal	Separator	Electrolyte
Raw Material	Lead dioxide	Lead	ABS	Rubber	Copper	Fiberglass	Sulfuric acid

Discharge Characteristics

Voltage	Run Time (Constant Current and Power 25°C 77°F)										
	3 min	5 min	15 min	30 min	45 min	1h	2h	3h	5h	8h	10h
9.6 V	8740	7600	4300	2760	2060	1492	840	630	420	280	248
10.2V	8400	6500	3860	2460	1980	1472	810	620	416	276	246
10.5V	7700	6160	3640	2240	1940	1448	780	610	410	272	242
10.8V	7040	5860	3160	2000	1880	1420	760	580	390	270	240

Discharge Characteristics Curve

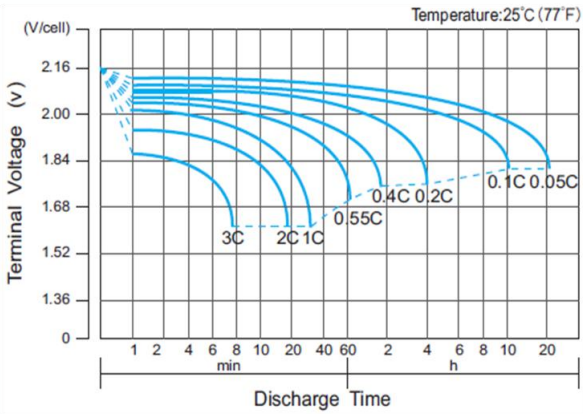

Charging Characteristics

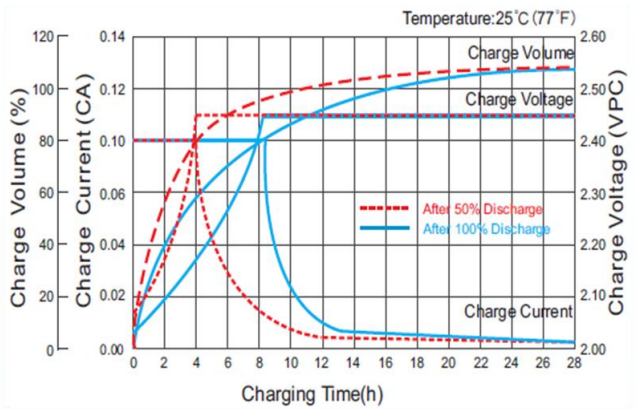

Cycle Life vs. Depth of Discharge (25°C)

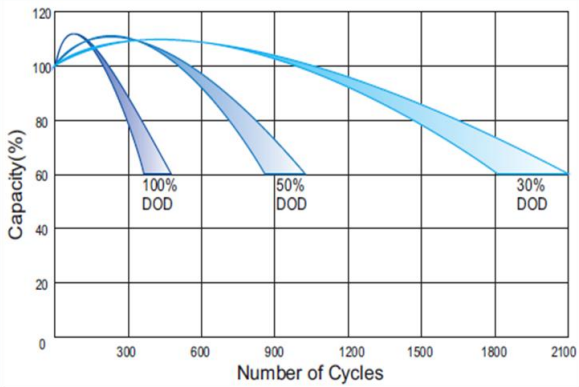

Temperature Effects on Capacity

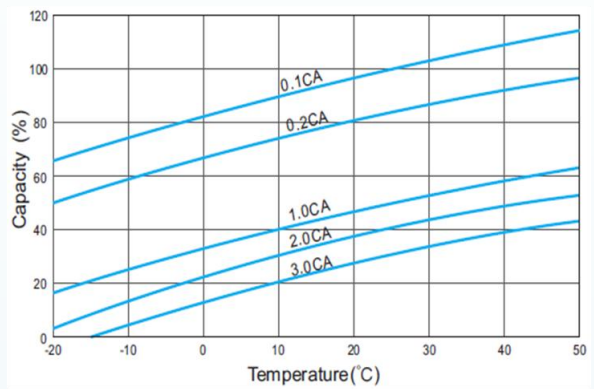

Effect of Temperature on Long Term Life

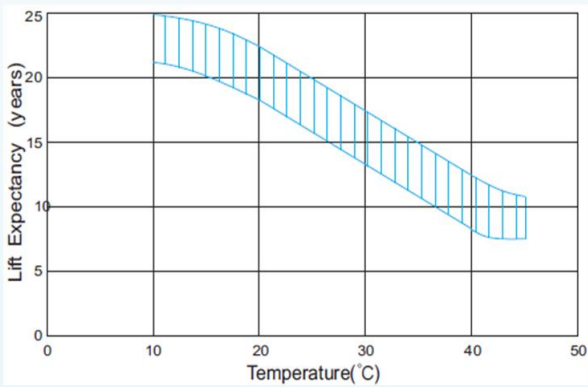

Storage Characteristics

